

www.hsflamingo.com



Wärmeluftöfen von Masterflamme

Perfekte Verbrennung mit großartigem Auftritt



wählen Sie Ihre **Farbe** ...

olive

braun - samten

grau

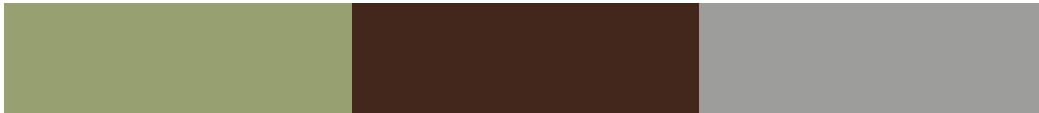

schwarz

creme



Eine optimale Verbrennung

Wird durch Zufuhr von Primär-, Sekundär- und Tertiärluft in den Brennraum ermöglicht.



Der Doppelwand- Konvektionsofen

Von der Unterseite strömt kalte Luft in die Rohre, wird dort erhitzt und als Warmluft in den Raum abgegeben.



Technischer Querschnitt Masterflamme®

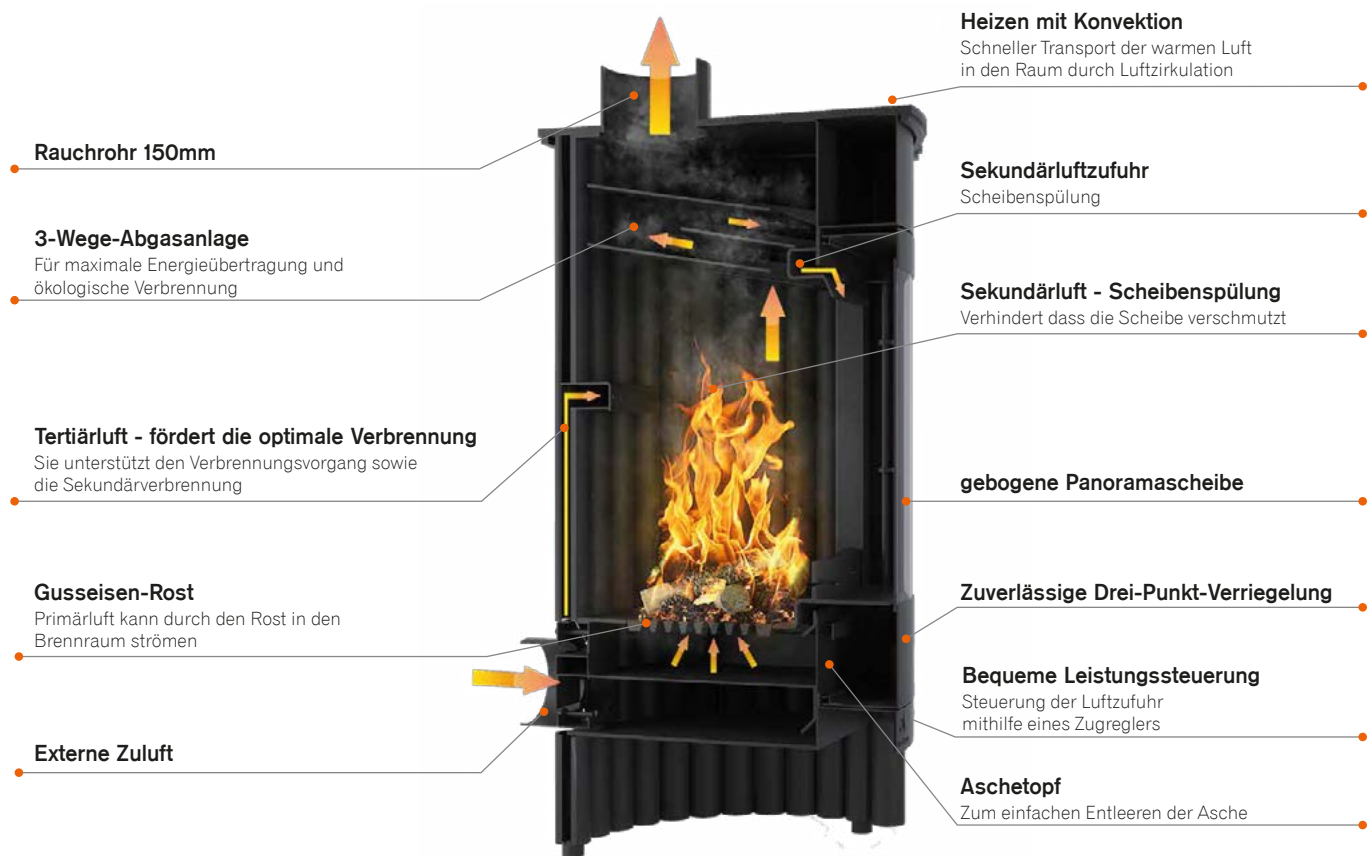

8-stündige Brenndauer



Leistungsbereich 3 – 21 kW



Beheizbarer Raum 60 – 420 m³



Scheitholzlänge 420 – 520 mm

Fan-Effekt

Wärme in Minutenschnelle

Die **Masterflamme Warmluftöfen** können für die Beheizung von Wohnräumen und Freizeiteinrichtungen genutzt werden. Durch die schnelle Heileistung und die Größe des Brennraums sind sie auch sehr beliebt für Atelierräume, Werkstätten und andere gewerbliche Bereiche.

Aufgrund ihres einzigartigen Designs haben sie die Fähigkeit, selbst große Räume schnell und gleichmäßig zu beheizen. Kalte Luft strömt am Boden direkt in die Rohre am Brennraum und wird durch die Verbrennung erwärmt. Die warme Luft steigt nach oben und wird wieder in den Raum abgegeben. Durch dieses Konvektionsprinzip ist es möglich, in kürzester Zeit viel Wärme zu erzeugen und Räume zu beheizen.



Kaminofen

piccolo I



schwarz



braun - samten



creme



grau



- + Primär-, Sekundär- und Tertiärluftzufuhr
- + Sekundärluft – für eine vollständige Verbrennung
- + Integrierte Scheibenspülung
- + Anschlussmöglichkeit für externe Zuluft
- + Aschetopf
- + Brennraumdichtung mit extra langer Lebensdauer



Topplatte

Technische Daten

Nennleistung kW	7
Leistungsbereich kW	3 - 11
Wirkungsgrad %	79
Brennstoffverbrauch kg/Stunde	2
Mindestkaminzug Pa	12
Rauchrohr-Durchmesser mm	150
maximale Scheitholzlänge cm	42
Gewicht kg	128
CO-Emission (bei 13 % O ₂) %	0.091
Abgastemperatur °C	278
beheizbares Raumvolumen m ³	75 - 275
Herstellergarantie	5 Jahre

olive

von HS Flamingo s.r.o. hergestellt

www.hsflamingo.com

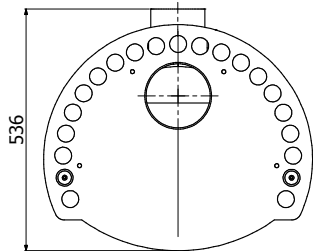
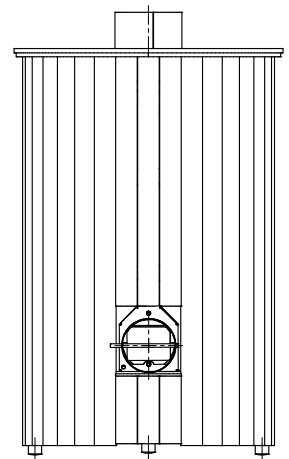
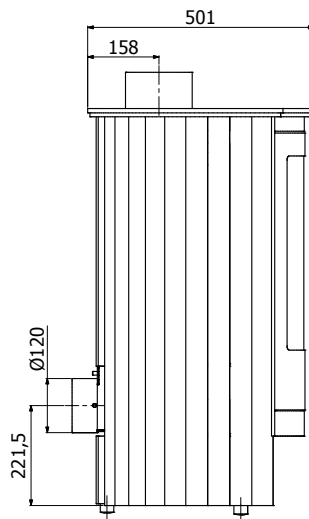
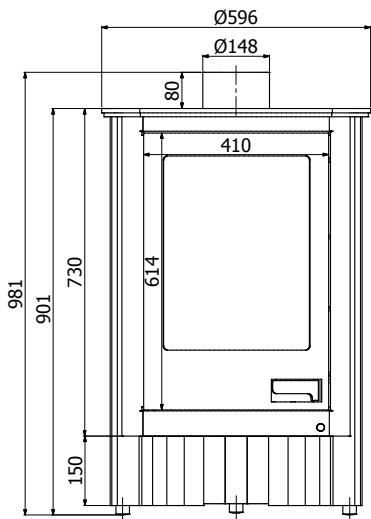





Kaminofen

piccolo II



schwarz



braun - samten



creme



olive



- + Primär-, Sekundär- und Tertiärluftzufuhr
- + Sekundärluft – für eine vollständige Verbrennung
- + Integrierte Scheibenspülung
- + Anschlussmöglichkeit für externe Zuluft
- + Aschetopf
- + Brennraumdichtung mit extra langer Lebensdauer



Topplatte

Technische Daten

Nennleistung kW	7
Leistungsbereich kW	3 - 11
Wirkungsgrad %	79
Brennstoffverbrauch kg/Stunde	2
Mindestkaminzug Pa	12
Rauchrohr-Durchmesser mm	150
maximale Scheitholzlänge cm	42
Gewicht kg	60 - 220
CO-Emission (bei 13 % O ₂) %	118
Abgastemperatur °C	0.091
beheizbares Raumvolumen m ³	278
Herstellergarantie	5 Jahre

grau

von HS Flamingo s.r.o. hergestellt

www.hsflamingo.com

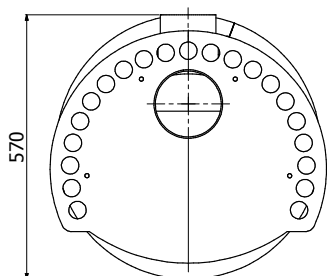
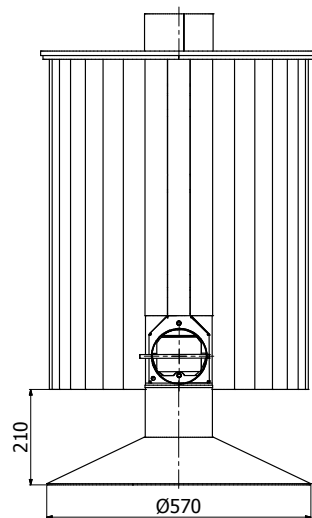
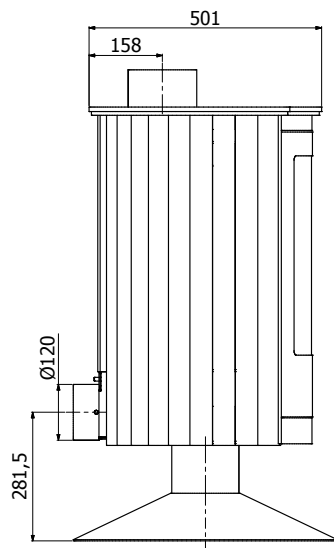
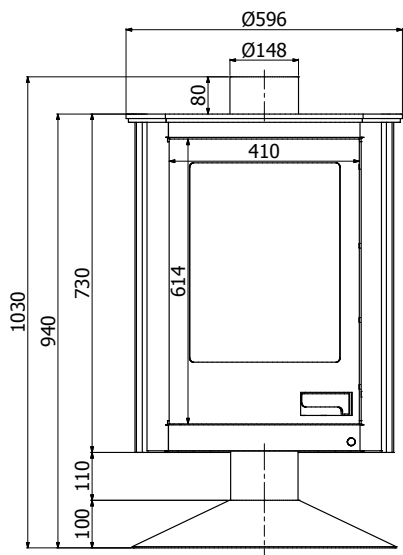





Kaminofen

medie I



braun - samten



creme



olive



grau



- + Primär-, Sekundär- und Tertiärluftzufuhr
- + Sekundärluft – für eine vollständige Verbrennung
- + Integrierte Scheibenspülung
- + Anschlussmöglichkeit für externe Zuluft
- + Aschetopf
- + Brennraumdichtung mit extra langer Lebensdauer



Topplatte

Technische Daten

Nennleistung kW	12
Leistungsbereich kW	8 - 16
Wirkungsgrad %	79
Brennstoffverbrauch kg/Stunde	3,5
Mindestkaminzug Pa	12
Rauchrohr-Durchmesser mm	150
maximale Scheitholzlänge cm	46
Gewicht kg	160 - 320
CO-Emission (bei 13 % O ₂) %	152
Abgastemperatur °C	0,093
beheizbares Raumvolumen m ³	299
Herstellergarantie	5 Jahre

schwarz

von HS Flamingo s.r.o. hergestellt

www.hsflamingo.com

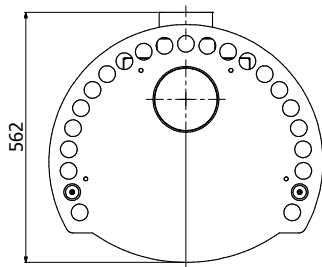
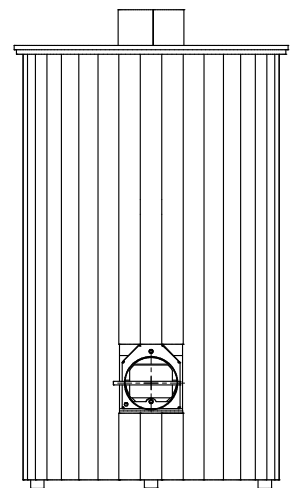
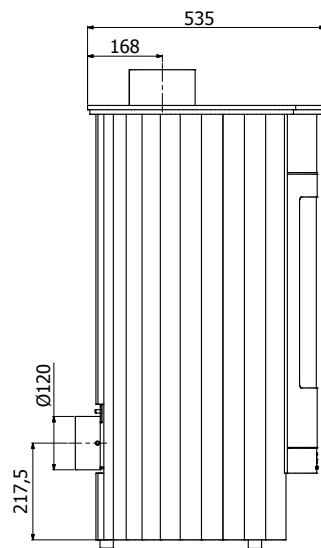
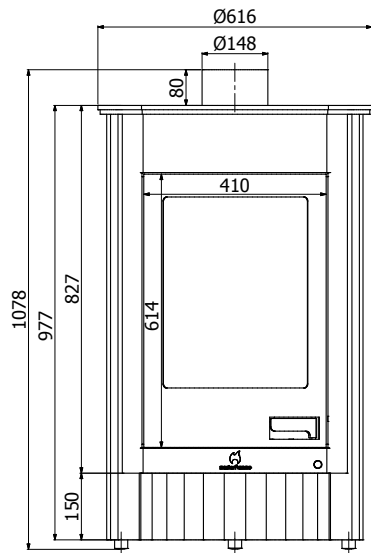





Kaminofen

medie II



schwarz



creme



olive



grau



- + Primär-, Sekundär- und Tertiärluftzufuhr
- + Sekundärluft – für eine vollständige Verbrennung
- + Integrierte Scheibenspülung
- + Anschlussmöglichkeit für externe Zuluft
- + Aschetopf
- + Brennraumdichtung mit extra langer Lebensdauer



Topplatte

Technische Daten

Nennleistung kW	12
Leistungsbereich kW	8 - 16
Wirkungsgrad %	79
Brennstoffverbrauch kg/Stunde	3,5
Mindestkaminzug Pa	12
Rauchrohr-Durchmesser mm	150
maximale Scheitholzlänge cm	46
Gewicht kg	160 - 320
CO-Emission (bei 13 % O ₂) %	141
Abgastemperatur °C	0,093
beheizbares Raumvolumen m ³	299
Herstellergarantie	5 Jahre

braun - samten

von HS Flamingo s.r.o. hergestellt

www.hsflamingo.com

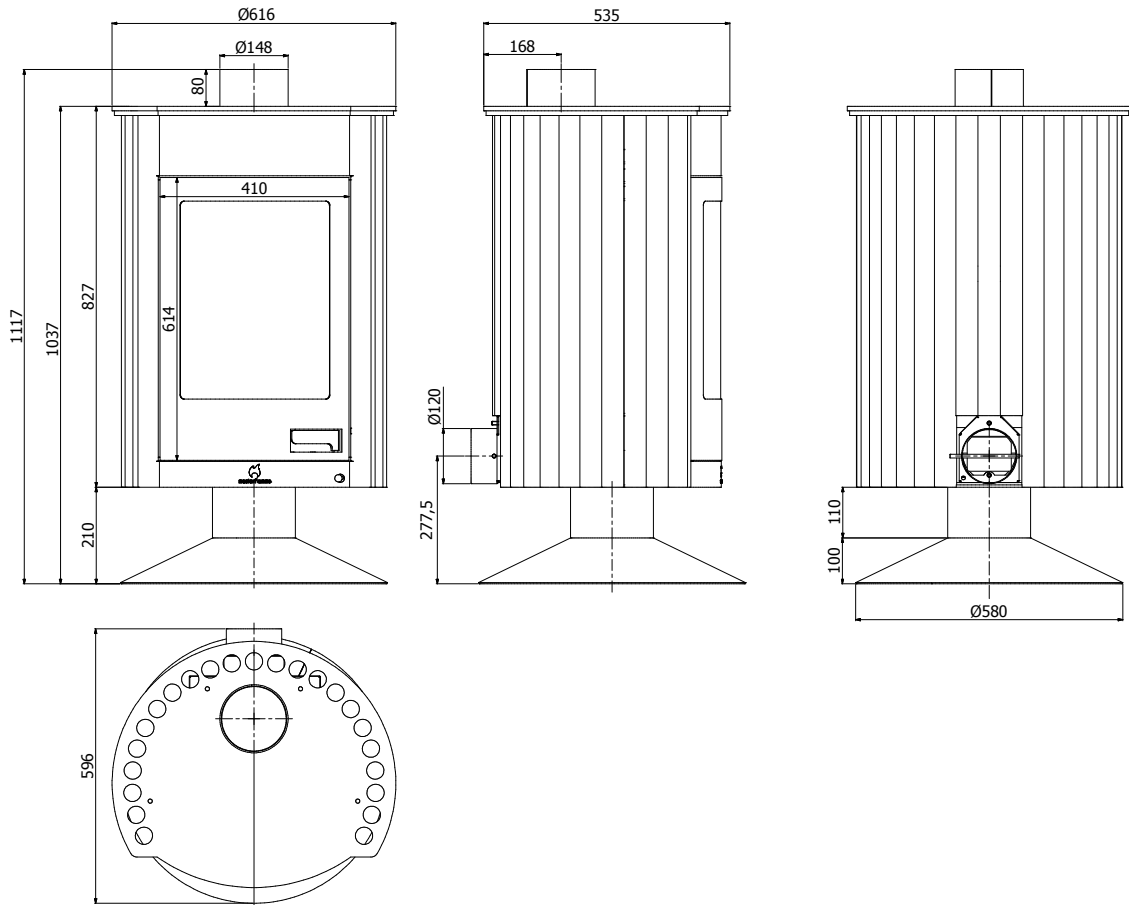





Kaminofen

grande I



braun - samten



creme



olive



grau



- + Primär-, Sekundär- und Tertiärluftzufuhr
- + Sekundärluft – für eine vollständige Verbrennung
- + Integrierte Scheibenspülung
- + Anschlussmöglichkeit für externe Zuluft
- + Aschetopf
- + Brennraumdichtung mit extra langer Lebensdauer



Topplatte

Technische Daten

Nennleistung kW	17
Leistungsbereich kW	13 - 21
Wirkungsgrad %	78
Brennstoffverbrauch kg/Stunde	5
Mindestkaminzug Pa	12
Rauchrohr-Durchmesser mm	150
maximale Scheitholzlänge cm	52
Gewicht kg	260 - 420
CO-Emission (bei 13 % O ₂) %	193
Abgastemperatur °C	0.095
beheizbares Raumvolumen m ³	320
Herstellergarantie	5 Jahre

schwarz

von HS Flamingo s.r.o. hergestellt

www.hsflamingo.com

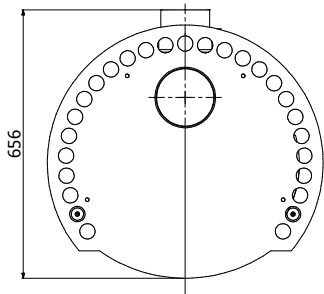
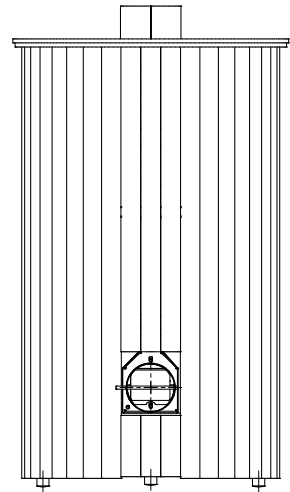
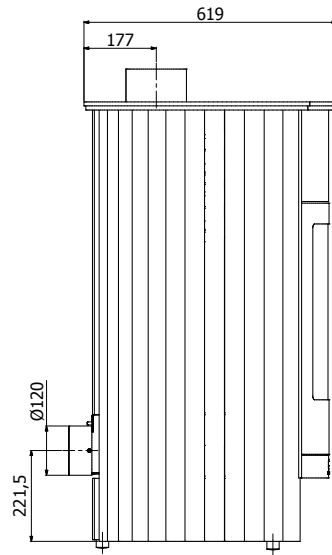
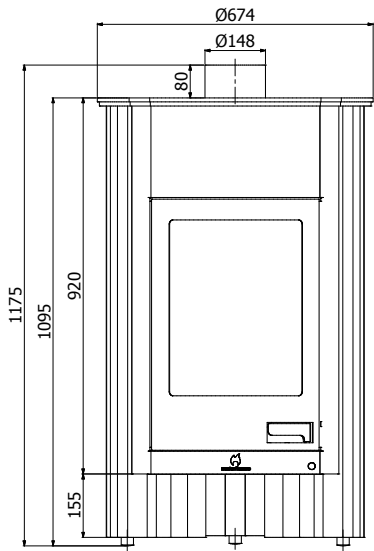





Kaminofen

grande II



Clean Burning



schwarz



creme



olive



grau



- + Primär-, Sekundär- und Tertiärluftzufuhr
- + Sekundärluft – für eine vollständige Verbrennung
- + Integrierte Scheibenspülung
- + Anschlussmöglichkeit für externe Zuluft
- + Aschetopf
- + Brennraumdichtung mit extra langer Lebensdauer



Topplatte

Technische Daten

Nennleistung kW	17
Leistungsbereich kW	13 - 21
Wirkungsgrad %	78
Brennstoffverbrauch kg/Stunde	5
Mindestkaminzug Pa	12
Rauchrohr-Durchmesser mm	150
maximale Scheitholzlänge cm	52
Gewicht kg	260 - 420
CO-Emission (bei 13 % O ₂) %	183
Abgastemperatur °C	0.095
beheizbares Raumvolumen m ³	320
Herstellergarantie	5 Jahre

braun - samten

von HS Flamingo s.r.o. hergestellt

www.hsflamingo.com

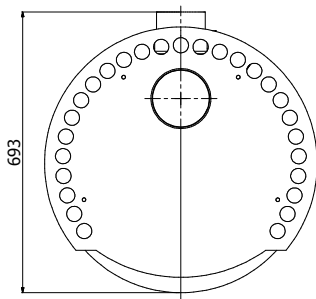
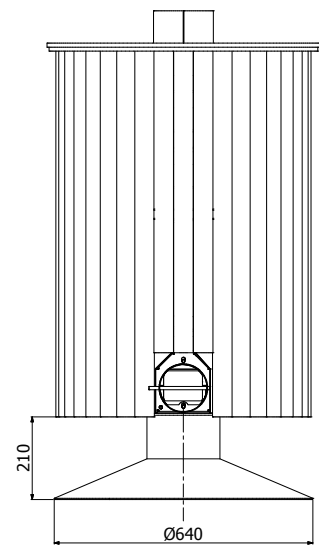
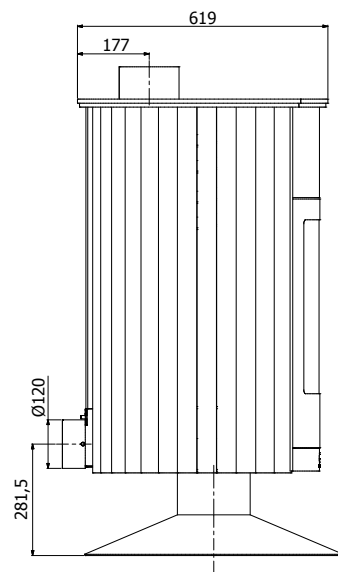
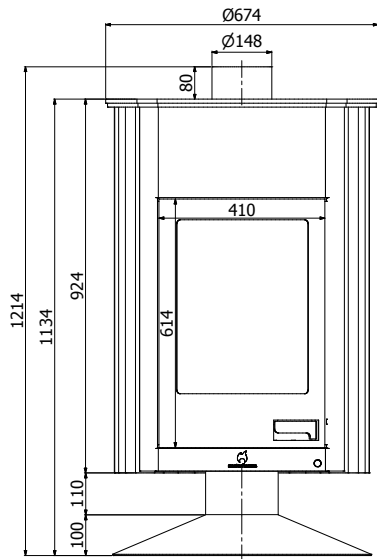





Das gesamte HS Flamingo - Angebot finden Sie auch unter
www.hsflamingo.com

Vertrieb:



HS Flamingo s.r.o.
třída Osvobození 65, CZ - 550 01
Broumov, Tschechische Republik

tel.: +420 491 422 647, fax: +420 491 521 140
e-mail: export@hsflamingo.cz

www.hsflamingo.com

Copyright © 2019 HS Flamingo s.r.o.
072019